

Automated Heated Build Platform

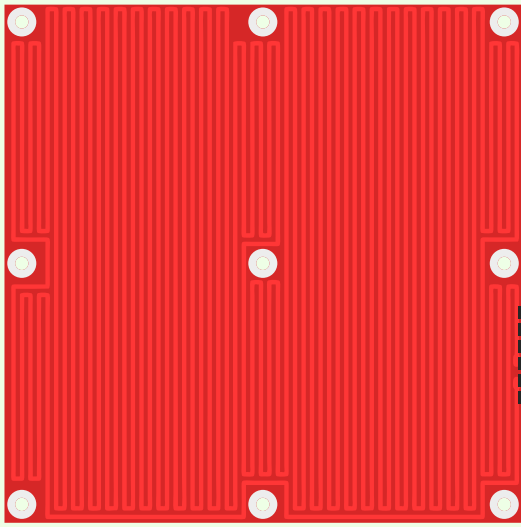

Heater Board



DC Motor

A-Axis Controller

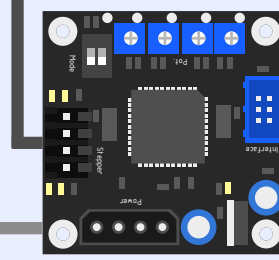

Stepper Motor

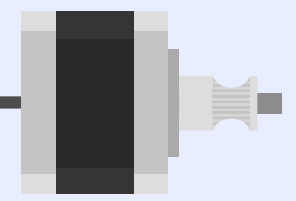

StepStruder

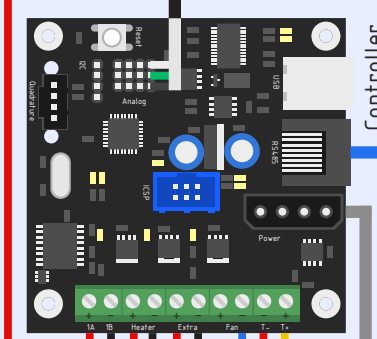

Controller

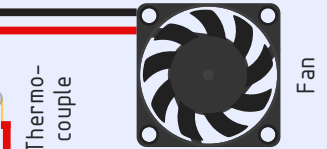

Fan

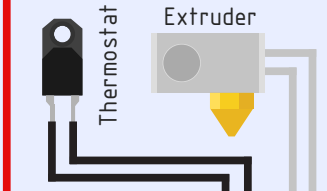

Extruder

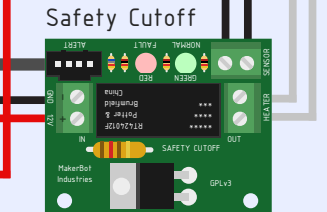

Safety Cutoff



ATX Power Supply

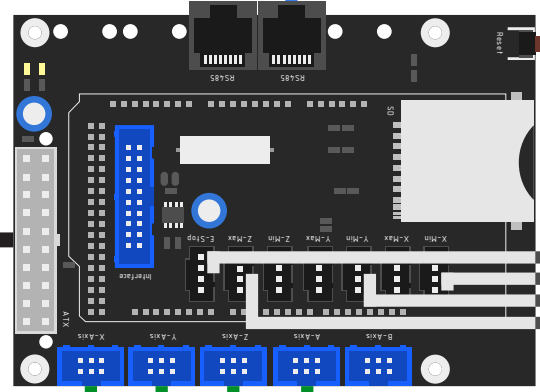

Motherboard

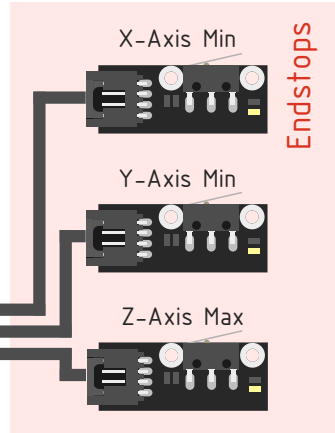

Endstops

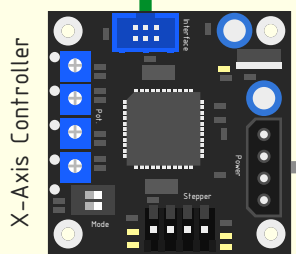

X-Axis Controller

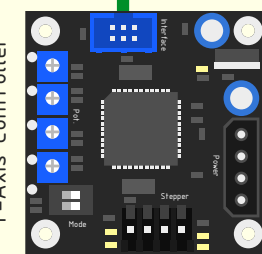

Y-Axis Controller

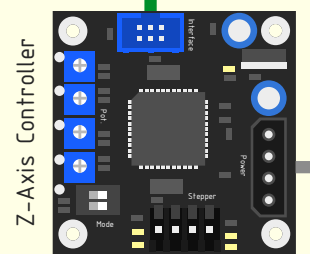

Z-Axis Controller

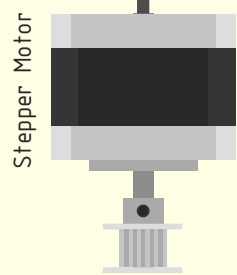

Stepper Motor

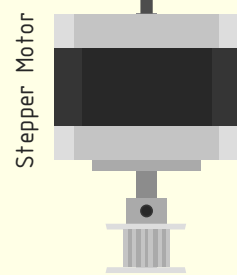

Stepper Motor

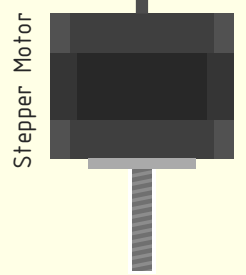

Stepper Motor

Axis Movement



MakerBot
Thing-O-Matic
MK7
Electronics

January 2012
ivc.no/makerbot